

## Photo DMOS-FET Relay

### Description

The **LT926** is a 1-Form A solid state relay in an 6 pin SMD package that employs optically coupled MOSFET technology to provide 3750V/5000V of input to output isolation. The optically coupled input is controlled by a highly efficient GaAlAs infrared LED and MOS FETs on the output side.

### Features

- Low driver power requirements (TTL/CMOS Compatible)
- No moving parts
- High reliability
- Arc-Free with no snubbing circuits
- 3750/5000Vrms Input/Output isolation

### Applications

- Telecommunications (PC, Electronic notepad)
- Measuring and Testing equipment
- Industrial control
- Security equipments
- High speed inspection machine

### Outline Dimensions

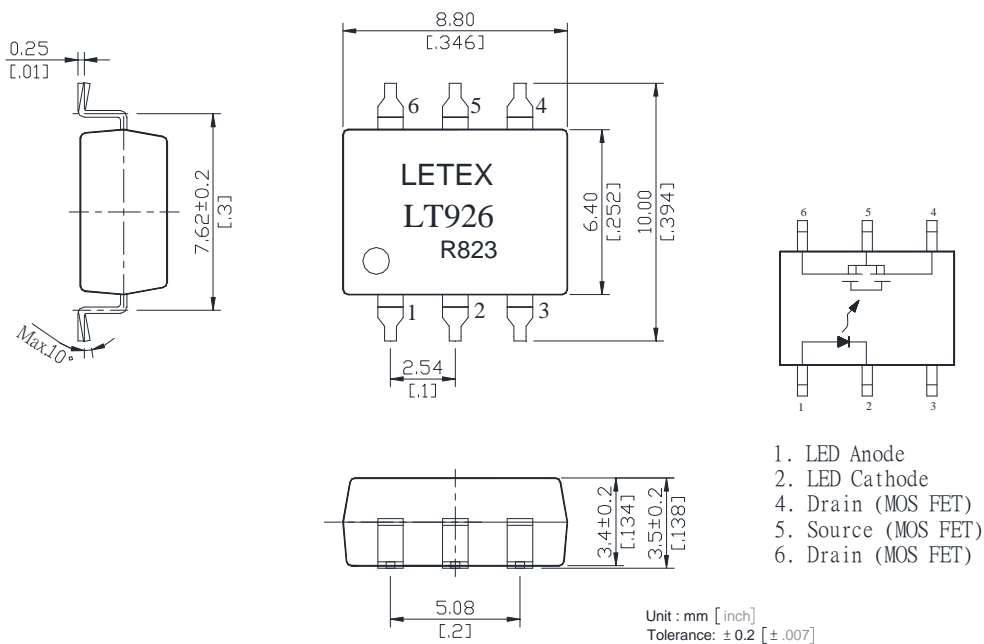

## Photo DMOS-FET Relay Specifications

**Part Name: LT926**

(Load voltage: 100V / Load current: 4.5A)

### Absolute Maximum Ratings (Ambient Temperature: 25°C)

Item		Symbol	Value	Units	Note	
Input	Continuous LED Current	I <sub>F</sub>	50	mA		
	Peak LED Current	I <sub>FP</sub>	1000	mA	f=100Hz, duty=1%	
	LED Reverse Voltage	V <sub>R</sub>	5	V		
	Input Power Dissipation	P <sub>In</sub>	75	mW		
Output	Load Voltage	V <sub>L</sub>	100	V(AC peak or DC)		
	Load Current	I <sub>L</sub>	4.5	A	A	AC
			5.0	A	B	DC
			6.0	A	C	DC
	Peak Load Current	I <sub>Peak</sub>	9.5	A	300 μs(1 pulse)	
Output Power Dissipation	P <sub>out</sub>	500	mW			
Total Power Dissipation		P <sub>T</sub>	550	mW		
I/O Breakdown Voltage		V <sub>I/O</sub>	3750	V <sub>rms</sub>	RH=60%, 1min	
I/O Breakdown Voltage(Suffix-V)		V <sub>I/O</sub>	5000	V <sub>rms</sub>	RH=60%, 1min	
Operating Temperature		T <sub>opr</sub>	-40 to +85	°C		
Storage Temperature		T <sub>stg</sub>	-40 to +100	°C		
Pin Soldering Temperature		T <sub>sol</sub>	260	°C	10 sec max.	

### Electrical Specifications (Ambient Temperature: 25°C)

Item		Symbol	MIN.	TYP.	MAX.	Units	Conditions
Input	LED Forward Voltage	V <sub>F</sub>		1.2	1.5	V	I <sub>F</sub> =10mA
	Operation LED Current	I <sub>F on</sub>		1.0	5.0	mA	
	Recovery LED Current	I <sub>F off</sub>	0.5	0.8		mA	
	Recovery LED Voltage	V <sub>F off</sub>	0.7			V	
Output	On-Resistance	R <sub>on</sub>		0.033	0.05	Ω	I <sub>F</sub> =10mA, I <sub>L</sub> =500mA, Time to flow is within 1 sec.
	Off-State Leakage Current	I <sub>Leak</sub>			1.0	uA	V <sub>L</sub> =Rating
	Output Capacitance	C <sub>out</sub>		1000		pF	V <sub>L</sub> =0, f=1MHz
Transmis sion	Turn-On Time	T <sub>on</sub>		1.0	2.5	ms	I <sub>F</sub> =10mA, I <sub>L</sub> =100mA,
	Turn-Off Time	T <sub>off</sub>		0.03	0.1	ms	
Coupled	I/O Isolation Resistance	R <sub>I/O</sub>	10 <sup>10</sup>			Ω	DC500V
	I/O Capacitance	C <sub>I/O</sub>		0.8	1.5	pF	f=1MHz

## Reference Data

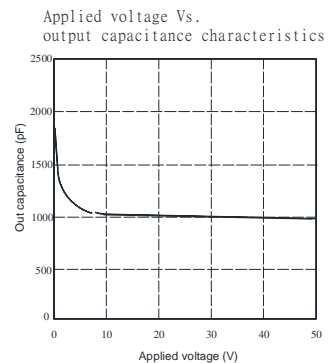
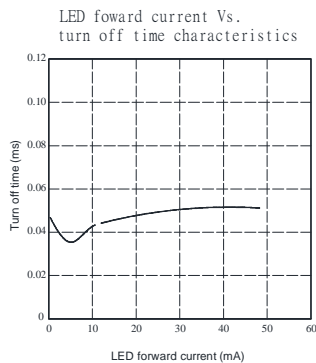
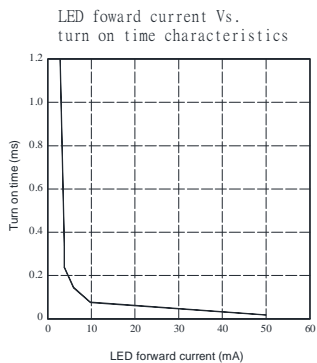
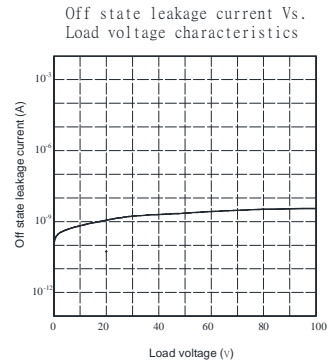
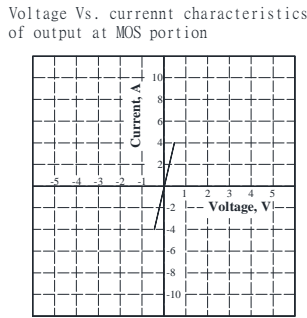
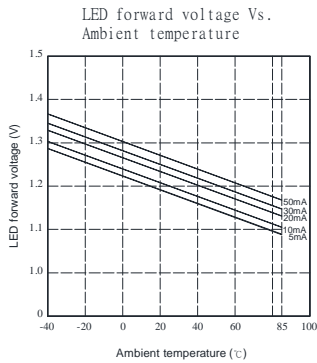
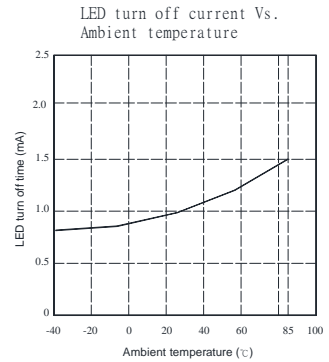
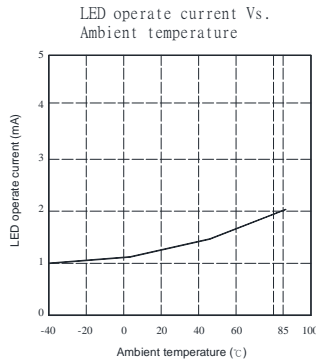
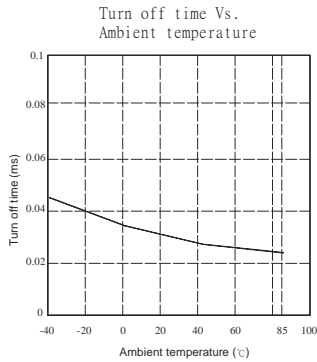
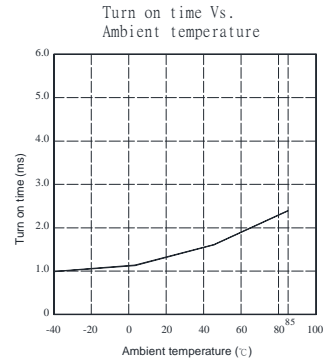
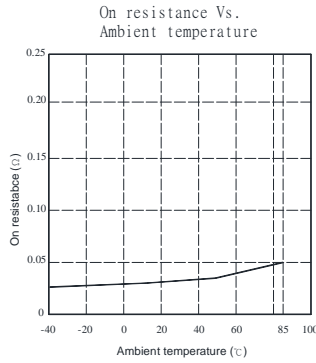
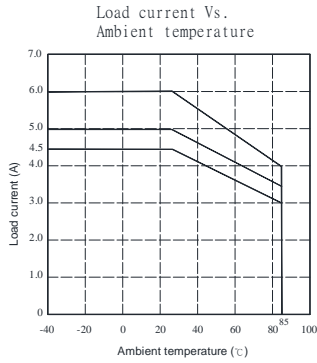

## Taping Specifications for Surface Mount Devices

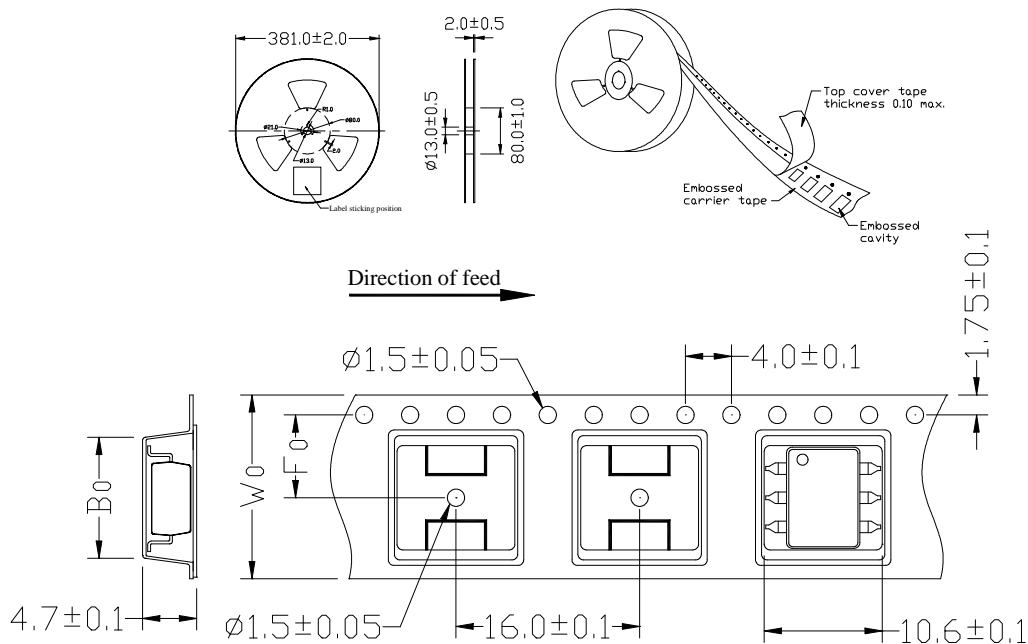

Unit: mm

TYPE	B0±0.1	F0±0.1	W0±0.1	15" REEL/PCS
6P	9.4	7.5	16	1000

### Recommended Mounting Pad

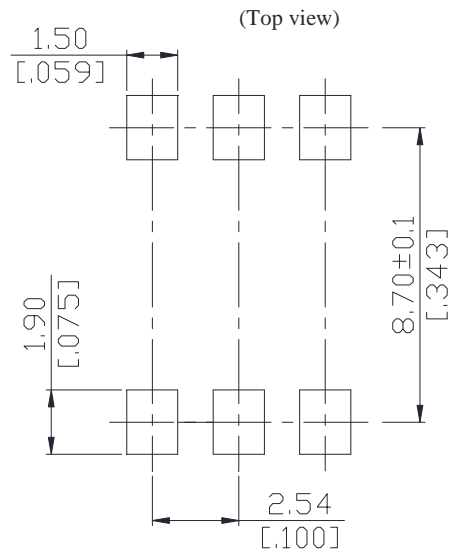

Unit : mm [inch]  
Tolerance : ±0.1

### Marking

(Each photo MOS Relay shall be marked with the following information)

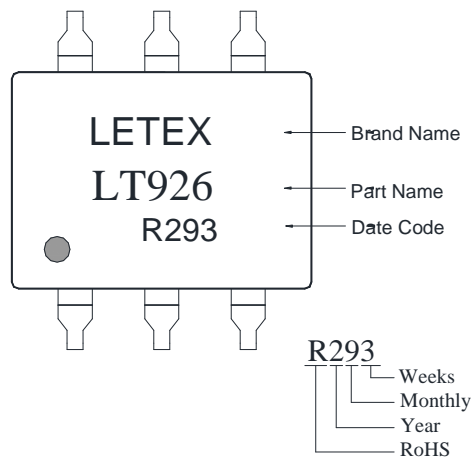

- Note: 1. There shall be leader of 230 mm minimum which may consist of carrier and or cover tape follower by a minimum of 160 mm of carrier tape sealed with cover tape.
2. There shall be a minimum of 160 mm of empty component pockets sealed with cover tape.
3. Devices are pockets in accordance with EIA standard EIA-481-A and specifications given above.